

200mA, SMD Switching Diode

FEATURES

- Designed for mounting on small surface
- Low Capacitance
- Low forward voltage drop
- Moisture sensitivity level: level 1, per J-STD-020
- RoHS Compliant
- Halogen-free according to IEC 61249-2-21

APPLICATIONS

- Switching mode power supply (SMPS)
- Adapters
- Lighting application
- On-board DC/DC converter



MECHANICAL DATA

- Case: SOT-23
- Molding compound meets UL 94 V-0 flammability rating
- Terminal: Matte tin plated leads, solderable per J-STD-002
- Meet JESD 201 class 1A whisker test
- Weight: 8 mg (approximately)



KEY PARAMETERS		
PARAMETER	VALUE	UNIT
I_F	200	mA
V_{RRM}	100	V
I_{FSM}	2	A
V_F at $I_F=10mA$	1	V
T_J Max.	150	°C
Package	SOT-23	

ABSOLUTE MAXIMUM RATINGS ($T_A = 25^\circ\text{C}$ unless otherwise noted)

PARAMETER		SYMBOL	VALUE	UNIT
Marking code on the device	MMBD4148		5D	
	MMBD4148CA		A1	
	MMBD4148CC		A4	
	MMBD4148SE		A7	
Repetitive peak reverse voltage		V_{RRM}	100	V
Forward current		I_F	200	mA
Repetitive peak forward surge current		I_{FRM}	700	mA
Non-repetitive peak forward surge current	at $t=1\mu\text{s}$	I_{FSM}	2	A
	at $t=1\text{s}$		1	
Junction temperature range		T_J	-55 to +150	°C
Storage temperature range		T_{STG}	-55 to +150	°C

THERMAL PERFORMANCE			
PARAMETER	SYMBOL	TYP	UNIT
Junction-to-ambient thermal resistance	$R_{\theta JA}$	357	$^{\circ}\text{C/W}$

ELECTRICAL SPECIFICATIONS ($T_A = 25^{\circ}\text{C}$ unless otherwise noted)					
PARAMETER	CONDITIONS	SYMBOL	MIN	MAX	UNIT
Forward voltage per diode ⁽¹⁾	$I_F = 10\text{mA}, T_J = 25^{\circ}\text{C}$	V_F	-	1.0	V
Reverse current per diode ⁽²⁾	$V_R = 20\text{V}, T_J = 25^{\circ}\text{C}$	I_R	-	25.0	nA
	$V_R = 75\text{V}, T_J = 25^{\circ}\text{C}$		-	5.0	μA
	$V_R = 20\text{V}, T_A = 150^{\circ}\text{C}$		-	50.0	
Reverse breakdown voltage	$I_R = 5\mu\text{A}, T_J = 25^{\circ}\text{C}$	$V_{(BR)}$	75	-	V
	$I_R = 100\mu\text{A}, T_J = 25^{\circ}\text{C}$		100	-	
Junction capacitance	$f = 1\text{MHz}, V_R = 0\text{V}$	C_J	-	4.0	pF
Reverse recovery time	$I_F = 10\text{mA}, I_R = 1\text{mA}, R_L = 100\Omega, V_R = 6\text{V}$	t_{rr}	-	4.0	ns

Notes:

1. Pulse test with $PW = 0.3\text{ ms}$
2. Pulse test with $PW = 30\text{ ms}$

ORDERING INFORMATION		
ORDERING CODE (Note 1)	PACKAGE	PACKING
MMBD414xx RFG	SOT-23	3K / 7" Reel
MMBD414xx R5G	SOT-23	10K / 13" Reel

Note:

1. "xx" defines part no. from "8" to "8SE"

CHARACTERISTICS CURVES

($T_A = 25^\circ\text{C}$ unless otherwise noted)

Fig. 1 Power Derating Curve

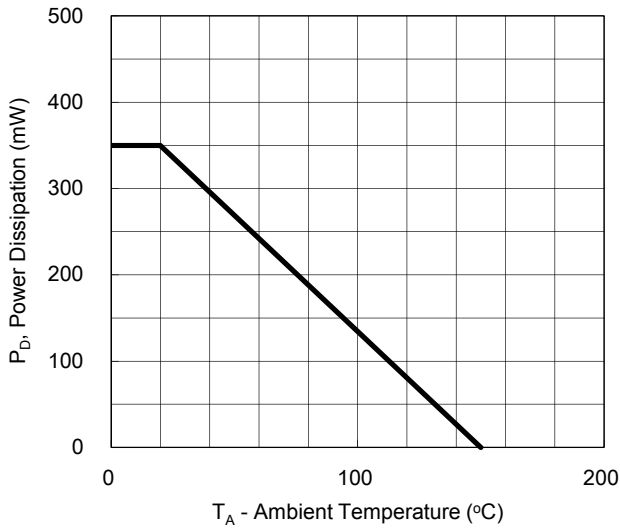

Fig.2 Forward Characteristics

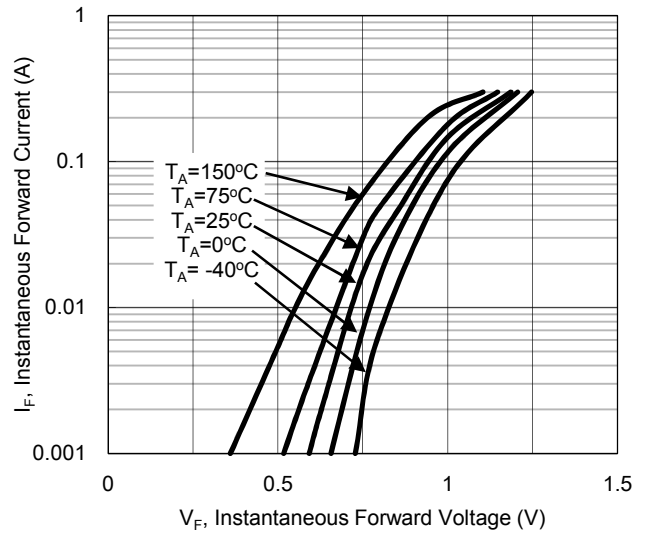

Fig.3 Typical Reverse Characteristics

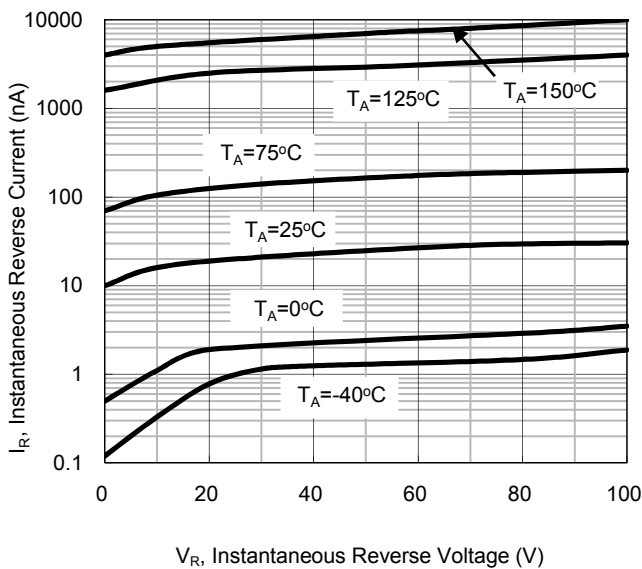
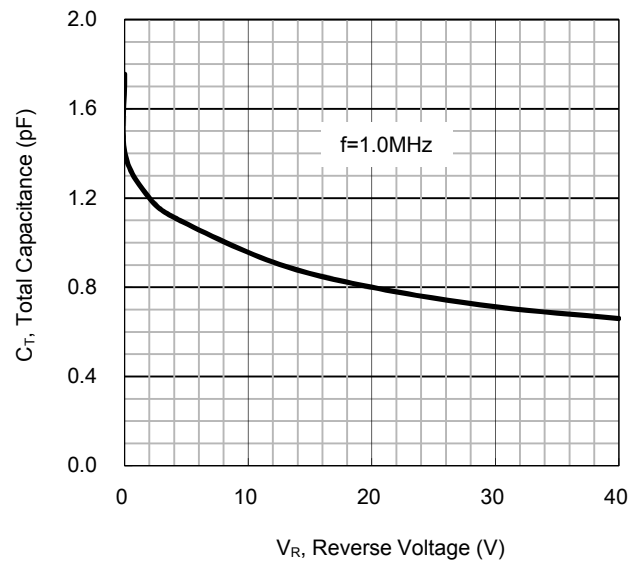
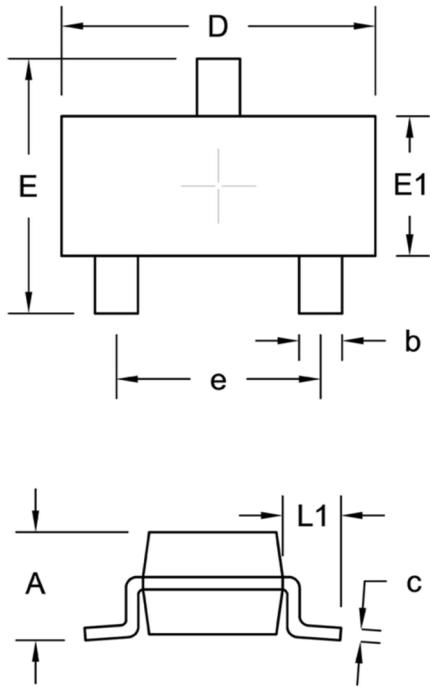

Fig.4 Typical Capacitance vs. Reverse Voltage



PACKAGE OUTLINE DIMENSION

SOT-23



DIM.	Unit (mm)		Unit (inch)	
	Min.	Max.	Min.	Max.
A	0.89	1.12	0.035	0.044
b	0.30	0.50	0.012	0.020
c	0.08	0.20	0.003	0.008
D	2.80	3.04	0.110	0.120
E	2.10	2.64	0.083	0.104
E1	1.20	1.40	0.047	0.055
e	1.90 BSC		0.075 BSC	
L1	0.54 REF.		0.021 REF.	

SUGGEST PAD LAYOUT

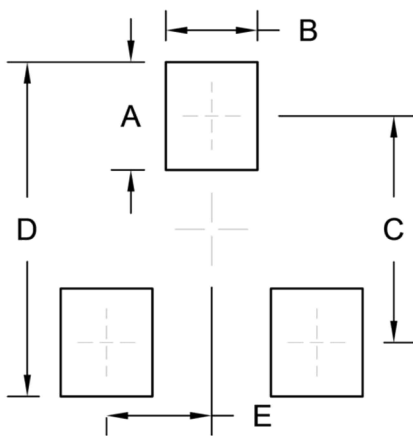

Symbol	Unit (mm)	Unit (inch)
A	1.00	0.039
B	0.85	0.033
C	2.10	0.083
D	3.10	0.122
E	0.98	0.039

PIN CONFIGURATION

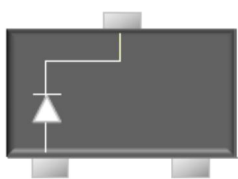

MMBD4148

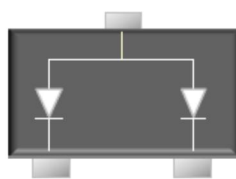

MMBD4148CA

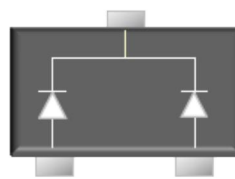

MMBD4148CC

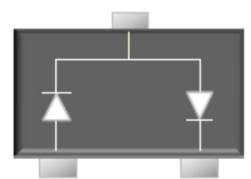

MMBD4148SE

Notice

Specifications of the products displayed herein are subject to change without notice. TSC or anyone on its behalf, assumes no responsibility or liability for any errors or inaccuracies.

Purchasers are solely responsible for the choice, selection, and use of TSC products and TSC assumes no liability for application assistance or the design of Purchasers' products.

Information contained herein is intended to provide a product description only. No license, express or implied, to any intellectual property rights is granted by this document. Except as provided in TSC's terms and conditions of sale for such products, TSC assumes no liability whatsoever, and disclaims any express or implied warranty, relating to sale and/or use of TSC products including liability or warranties relating to fitness for a particular purpose, merchantability, or infringement of any patent, copyright, or other intellectual property right.

The products shown herein are not designed for use in medical, life-saving, or life-sustaining applications. Customers using or selling these products for use in such applications do so at their own risk and agree to fully indemnify TSC for any damages resulting from such improper use or sale.

Mouser Electronics

Authorized Distributor

Click to View Pricing, Inventory, Delivery & Lifecycle Information:

[Taiwan Semiconductor:](#)

[MMBD4148CC RFG](#) [MMBD4148CA RFG](#) [MMBD4148SE RFG](#) [MMBD4148 RFG](#) [MMBD4148CA R5G](#)